

BUV21

SWITCHMODE Series NPN Silicon Power Transistor

... designed for high speed, high current, high power applications.

- High DC current gain:
h_{FE} min. = 20 at I_C = 12 A
- Low V_{CE(sat)}, V_{CE(sat)} max. = 0.6 V at I_C = 8 A

Very fast switching times:

TF max. = 0.4 μs at I_C = 25 A

**40 AMPERES
NPN SILICON
POWER
METAL TRANSISTOR
200 VOLTS
250 WATTS**

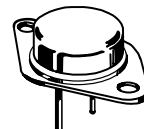

**CASE 197A-05
TO-204AE
(TO-3)**

MAXIMUM RATINGS

Rating	Symbol	Value	Unit
Collector-Emitter Voltage	V _{CEO(sus)}	200	Vdc
Collector-Base Voltage	V _{CB0}	250	Vdc
Emitter-Base Voltage	V _{EB0}	7	Vdc
Collector-Emitter Voltage (V _{BE} = -1.5 V)	V _{CEX}	250	Vdc
Collector-Emitter Voltage (R _{BE} = 100 Ω)	V _{CER}	240	Vdc
Collector-Current — Continuous	I _C	40	Adc
— Peak (pw ≤ 10 ms)	I _{CM}	50	Apk
Base-Current continuous	I _B	8	Adc
Total Power Dissipation @ T _C = 25°C	P _D	150	Watts
Operating and Storage Junction Temperature Range	T _J , T _{stg}	-65 to 200	°C

THERMAL CHARACTERISTICS

Characteristic	Symbol	Max	Unit
Thermal Resistance, Junction to Case	θ _{JC}	0.7	°C/W

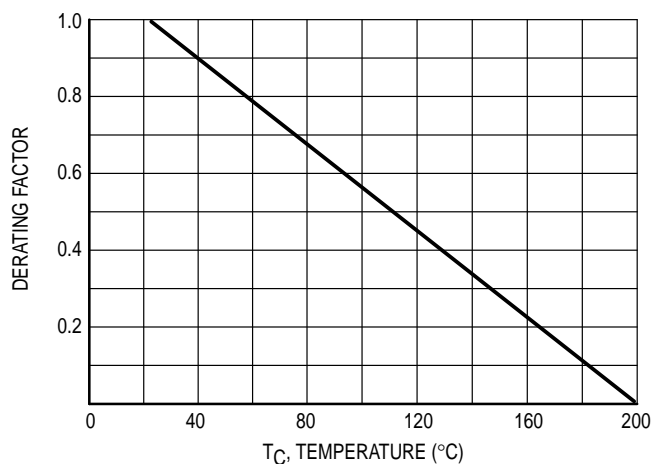

Figure 1. Power Derating

SWITCHMODE is a trademark of Motorola, Inc.

REV 7

BUV21**ELECTRICAL CHARACTERISTICS** ($T_C = 25^\circ\text{C}$ unless otherwise noted)

Characteristic	Symbol	Min	Max	Unit
OFF CHARACTERISTICS¹				
Collector–Emitter Sustaining Voltage ($I_C = 200\text{ mA}$, $I_B = 0$, $L = 25\text{ mH}$)	$V_{CEO(sus)}$	200		Vdc
Collector Cutoff Current at Reverse Bias: ($V_{CE} = 250\text{ V}$, $V_{BE} = -1.5\text{ V}$) ($V_{CE} = 250\text{ V}$, $V_{BE} = -1.5\text{ V}$, $T_C = 125^\circ\text{C}$)	I_{CEX}		3.0 12.0	mAdc
Collector–Emitter Cutoff Current ($V_{CE} = 160\text{ V}$)	I_{CEO}		3.0	mAdc
Emitter–Base Reverse Voltage ($I_E = 50\text{ mA}$)	V_{EBO}	7		V
Emitter–Cutoff Current ($V_{EB} = 5\text{ V}$)	I_{EBO}		1.0	mAdc

SECOND BREAKDOWN

Second Breakdown Collector Current with base forward biased ($V_{CE} = 20\text{ V}$, $t = 1\text{ s}$) ($V_{CE} = 140\text{ V}$, $t = 1\text{ s}$)	$I_{S/b}$	12 0.15		Adc
--	-----------	------------	--	-----

ON CHARACTERISTICS¹

DC Current Gain ($I_C = 12\text{ A}$, $V_{CE} = 2\text{ V}$) ($I_C = 25\text{ A}$, $V_{CE} = 4\text{ V}$)	h_{FE}	20 10	60	
Collector–Emitter Saturation Voltage ($I_C = 12\text{ A}$, $I_B = 1.2\text{ A}$) ($I_C = 25\text{ A}$, $I_B = 3\text{ A}$)	$V_{CE(sat)}$		0.6 1.5	Vdc
Base–Emitter Saturation Voltage ($I_C = 25\text{ A}$, $I_B = 3\text{ A}$)	$V_{BE(sat)}$		1.5	Vdc

DYNAMIC CHARACTERISTICS

Current Gain – Bandwidth Product ($V_{CE} = 15\text{ V}$, $I_C = 2\text{ A}$, $f = 4\text{ MHz}$)	f_T	8.0		MHz
--	-------	-----	--	-----

SWITCHING CHARACTERISTICS (Resistive Load)

Turn-on Time	$(I_C = 25\text{ A}$, $I_{B1} = I_{B2} = 3\text{ A}$, $V_{CC} = 100\text{ V}$, $R_C = 4\ \Omega$)	t_{on}	1.0	μs
Storage Time		t_s	1.8	
Fall Time		t_f	0.4	

¹ Pulse Test: Pulse Width $\leq 300\ \mu\text{s}$, Duty Cycle $\leq 2\%$.

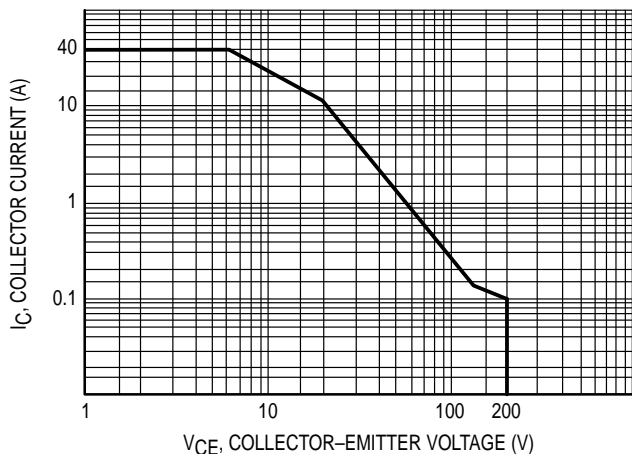

Figure 2. Active Region Safe Operating Area

There are two limitations on the power handling ability of a transistor: average junction temperature and second breakdown. Safe operating area curves indicate $I_C - V_{CE}$ limits of the transistor that must be observed for reliable operation i.e., the transistor must not be subjected to greater dissipation than the curves indicate.

The data of Figure 2 is based on $T_C = 25^\circ\text{C}$, $T_{J(pk)}$ is variable depending on power level. Second breakdown limitations do not derate the same as thermal limitations.

At high case temperatures, thermal limitations will reduce the power that can be handled to values less than the limitations imposed by second breakdown.

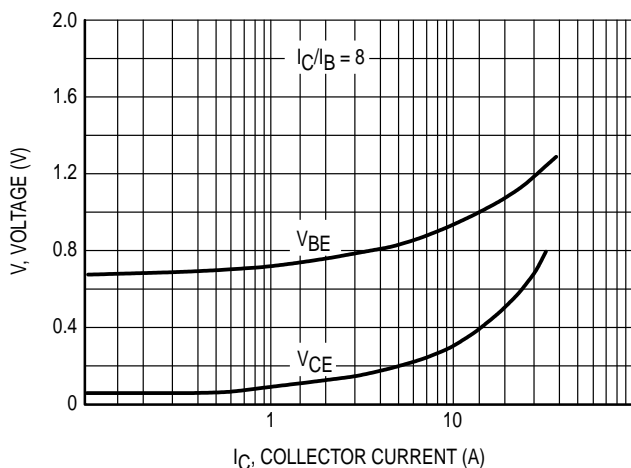

Figure 3. "On" Voltages

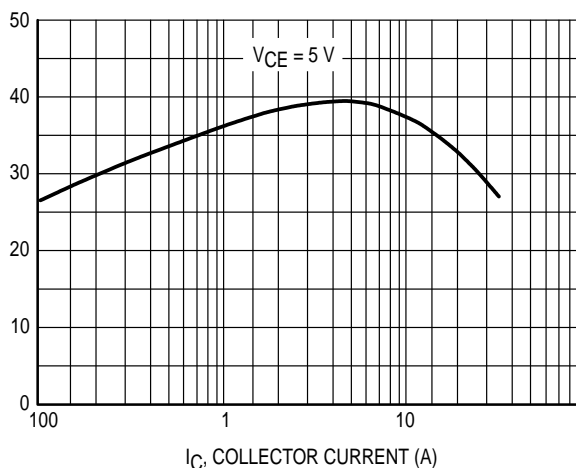

Figure 4. DC Current Gain

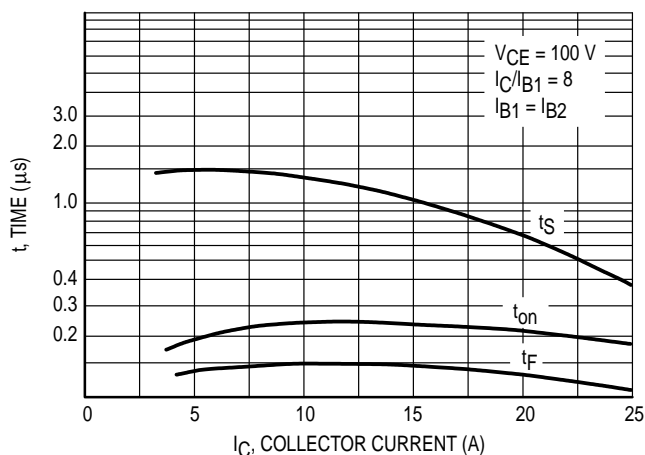
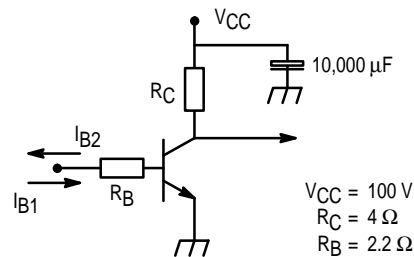

Figure 5. Resistive Switching Performance



$R_C - R_B$: Non inductive resistances

Figure 6. Switching Times Test Circuit

PACKAGE DIMENSIONS

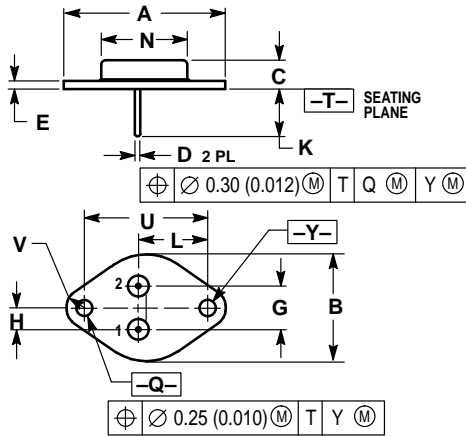

- NOTES:
 1. DIMENSIONING AND TOLERANCING PER ANSI Y14.5M, 1982.
 2. CONTROLLING DIMENSION: INCH.

DIM	INCHES		MILLIMETERS	
	MIN	MAX	MIN	MAX
A	1.530 REF		38.86 REF	
B	0.990	1.050	25.15	26.67
C	0.250	0.335	6.35	8.51
D	0.057	0.063	1.45	1.60
E	0.060	0.070	1.53	1.77
G	0.430 BSC		10.92 BSC	
H	0.215 BSC		5.46 BSC	
K	0.440	0.480	11.18	12.19
L	0.665 BSC		16.89 BSC	
N	0.760	0.830	19.31	21.08
Q	0.151	0.165	3.84	4.19
U	1.187 BSC		30.15 BSC	
V	0.131	0.188	3.33	4.77

STYLE 1:
 PIN 1. BASE
 2. EMITTER
 CASE: COLLECTOR

CASE 197A-05
 TO-204AE (TO-3)
 ISSUE J

Motorola reserves the right to make changes without further notice to any products herein. Motorola makes no warranty, representation or guarantee regarding the suitability of its products for any particular purpose, nor does Motorola assume any liability arising out of the application or use of any product or circuit, and specifically disclaims any and all liability, including without limitation consequential or incidental damages. "Typical" parameters can and do vary in different applications. All operating parameters, including "Typicals" must be validated for each customer application by customer's technical experts. Motorola does not convey any license under its patent rights nor the rights of others. Motorola products are not designed, intended, or authorized for use as components in systems intended for surgical implant into the body, or other applications intended to support or sustain life, or for any other application in which the failure of the Motorola product could create a situation where personal injury or death may occur. Should Buyer purchase or use Motorola products for any such unintended or unauthorized application, Buyer shall indemnify and hold Motorola and its officers, employees, subsidiaries, affiliates, and distributors harmless against all claims, costs, damages, and expenses, and reasonable attorney fees arising out of, directly or indirectly, any claim of personal injury or death associated with such unintended or unauthorized use, even if such claim alleges that Motorola was negligent regarding the design or manufacture of the part. Motorola and are registered trademarks of Motorola, Inc. Motorola, Inc. is an Equal Opportunity/Affirmative Action Employer.

How to reach us:
 USA / EUROPE: Motorola Literature Distribution;
 P.O. Box 20912; Phoenix, Arizona 85036. 1-800-441-2447

JAPAN: Nippon Motorola Ltd.; Tatsumi-SPD-JLDC, Toshikatsu Otsuki,
 6F Seibu-Butsuryu-Center, 3-14-2 Tatsumi Koto-Ku, Tokyo 135, Japan. 03-3521-8315

MFAX: RMFAX0@email.sps.mot.com - TOUCHTONE (602) 244-6609
 INTERNET: http://Design-NET.com

HONG KONG: Motorola Semiconductors H.K. Ltd.; 8B Tai Ping Industrial Park,
 51 Ting Kok Road, Tai Po, N.T., Hong Kong. 852-26629298

